

SETUP SHEET



TRACK CONDITIONS

Type: Carpet Asphalt Open Med. Tight
 Place: Indoor Outdoor Traction: High Med. Low
 Surface: Smooth Med. Bumpy Track Temp/Air Temp: _____ / _____
 Note: _____

FRONT SUSPENSION

Track Width: _____ mm Gear Diff _____ wt
 Toe Angle: _____ ° One Way
 Caster: _____ ° Spool
 Camber: _____ °
 Ride Height: _____ mm Anti-Roll Bar: Ø _____ mm
 Down Stop: _____ mm

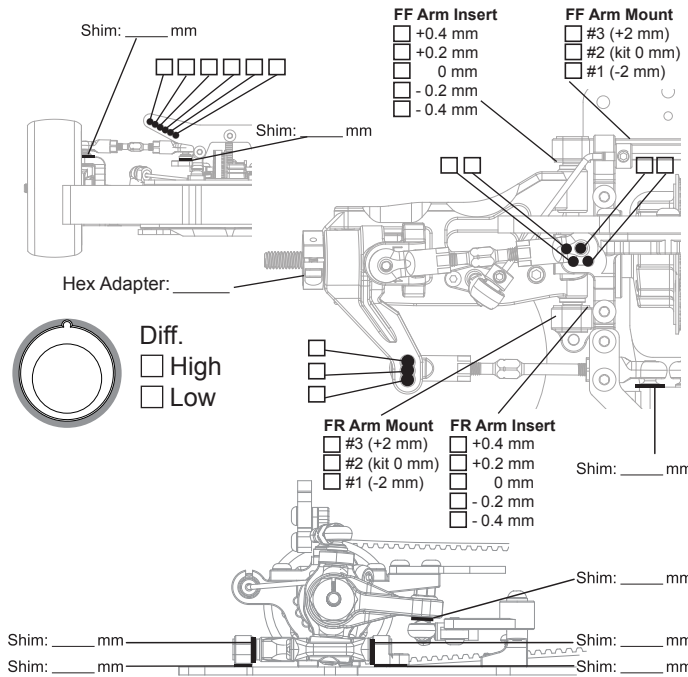

REAR SUSPENSION

Track Width: _____ mm Gear Diff _____ wt
 Toe Angle: _____ °
 Camber: _____ °
 Ride Height: _____ mm
 Down Stop: _____ mm Anti-Roll Bar: Ø _____ mm

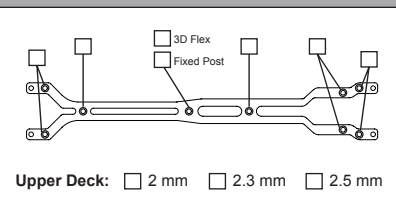
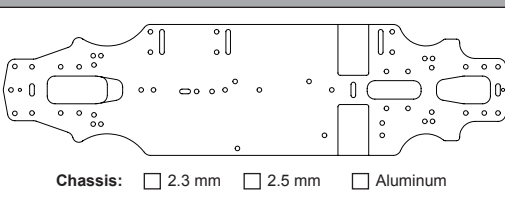
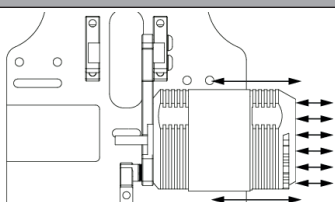
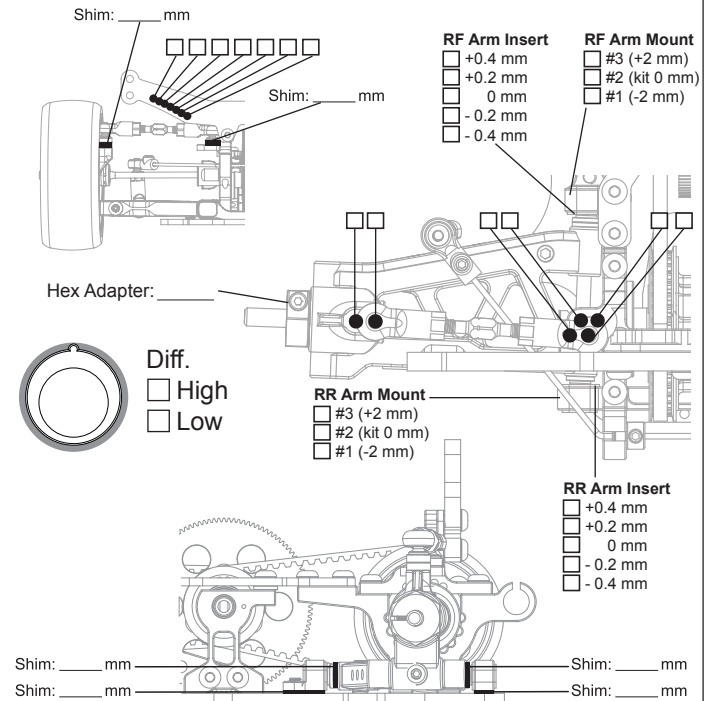

ELECTRONICS

Servo: _____
 ESC: _____
 Battery: _____

MOTOR

Brand: _____
 Turns: _____
 Timing: _____

ESC

Punch: _____
 Initial Brake: _____
 Drag Brake: _____
 ESC Timing Turbo Timing

DRIVE RATIO

Spur _____ T
 Pinion _____ T X1.9 = _____

TIRES

Insert: _____
 Wheel: _____
 Shore/deg: _____
 Compound: _____
 Tire Temp: _____
 Tire additive: _____
 Treated Area

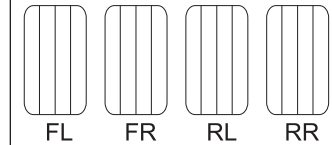

SHOCKS

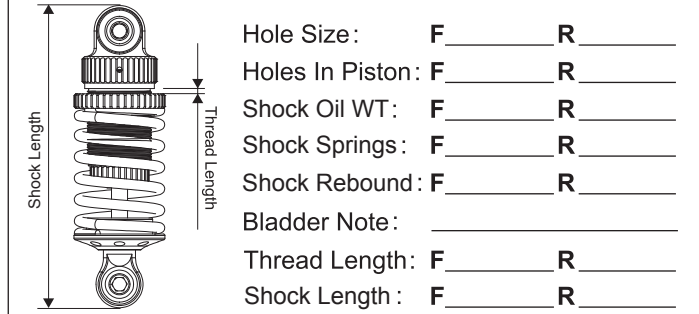

BODY

